



AGH

المجموعة العربية القابضة ذ.م.م
ARABIAN GROUP HOLDING LLC





Our Journey, Since 1967...

ARABIAN GROUP HOLDING, a wholly local company, has distinguished itself as a leading solutions provider in the region. Founded in 1967 by Chairman Mr. Ali Baslaib, the holding has grown into a licensed, certified, and award-winning entity. Today, it encompasses 35 subsidiaries with branches across Abu Dhabi, Dubai, Sharjah, and Al Ain.



AGH

المجموعة العربية القابضة ذ.م.م.
ARABIAN GROUP HOLDING LLC



Our Vision

“Maximizing the stakeholder accounts which is the life blood of our organization, by achieving and demonstrating the ability to sustain high growth in revenues and net profits, which will make Arabian Company an attractive and trusting investment opportunity”.

Our Mission

“To emerge as a leading and vital player in the UAE market, by providing niche solutions and services to all kinds of domains, such as International, Fast Growing Companies, Government Departments etc. and to celebrate healthy relationships achieved.”

AGH

المجموعة العربية القابضة س.م.م.
ARABIAN GROUP HOLDING LLC

We have more than 15,000 square meters of storage facility across UAE "Abu Dhabi-Al Ain -Sharjah

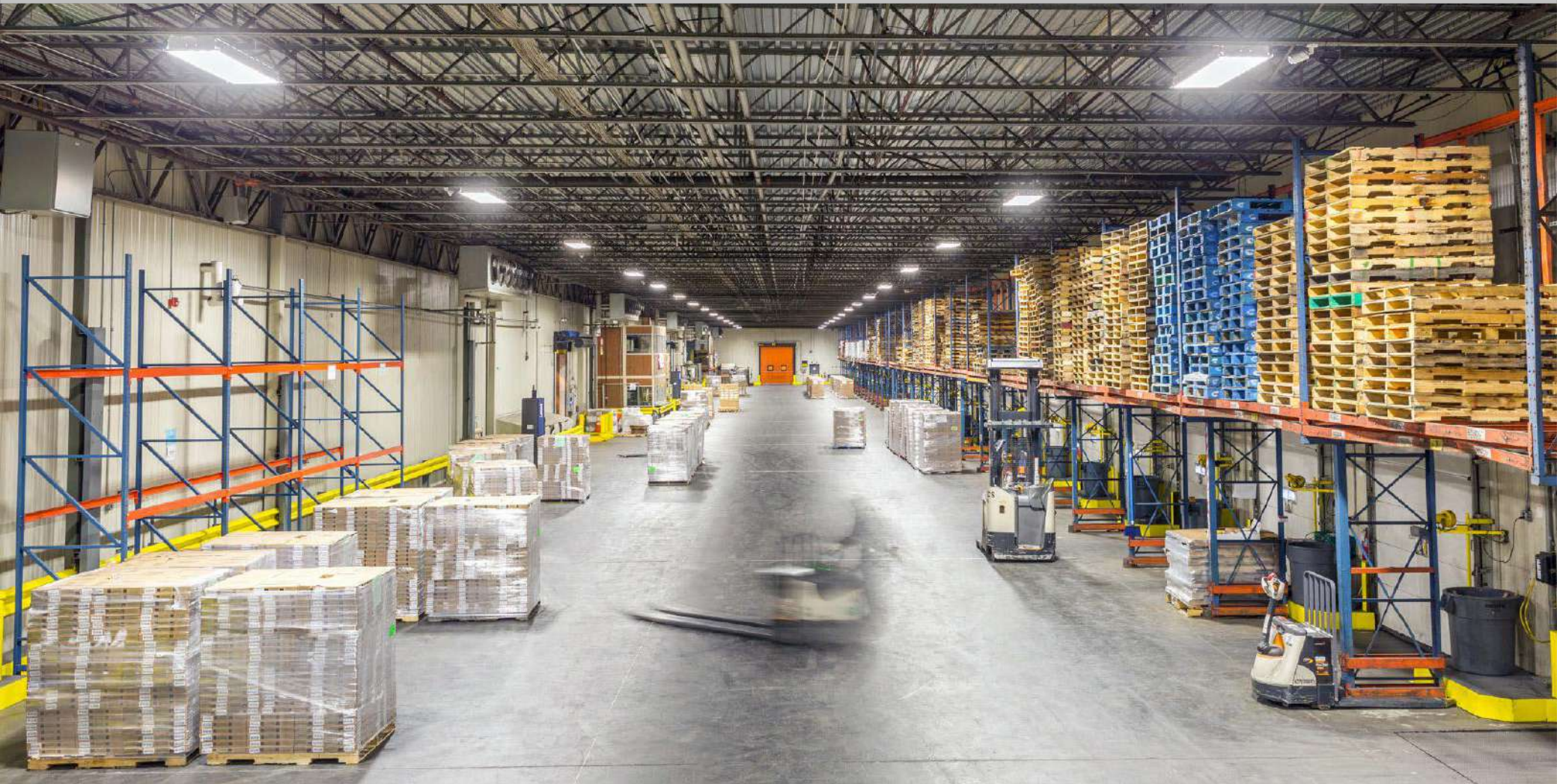

AGH

المجموعة العربية القابضة ذ.م.م.
ARABIAN GROUP HOLDING LL

AGH

المجموعة العربية القابضة ذ.م.م
ARABIAN GROUP HOLDING LLC



ARABIAN COMPANY

Few can match the prowess of Arabian Company in the field of Office Furniture. Growing in strength in this business for over five decades. Arabian Company has helped some of the country's leading institutions redefine their interiors through its sourcing and fit-out of office furniture and space



FLOORS & MORE

Our flooring and wall finishing solutions are all provided by Floors & More, a leader in its field of expertise. Leading American, European, and Asian Brands such as EGE Carpet, CBI Raised Flooring, Newmore and Murek Wall Covering, and Alkins Roller Blinds are among those that have chosen Floors & More as their partner of choice



THE AB WOOD INDUSTRIES

A part of Arabian Group of Companies is a pioneer in the field of custom-made furniture manufacturing and designing of optimum quality, with more than 40 years of expertise



SMART DIMENSIONS

So deep is our insight into detail that we have a sister firm that is dedicated to the field of partitioning systems and acoustic solutions. From supplying to installation, SMART Dimensions is a leader in all types of partitioning systems ranging from demountable partitions to wooden and metallic ones and acoustic materials and finishes.



TAKHZEEN

A complete provider, importer and stockiest of Smart Storage and Filling System Department (SS&FS Dept.), TAKHZEEN offers vast experience in the field of maximizing space both vertically as well as horizontally. This is your one-stop shop for all things storage ranging from HanelRotomat system to Electrical and Mechanical Mobile shelving.



ARCO INTERIORS

ARCO Interiors L.L.C. is a specialist in interior solutions providing Fullscope turnkey interior design, fit out and furnishings. We are highly regarded for our ability to deliver cost effective, time efficient and high quality projects. Our close-knit team of designers, architects and engineers are able to translate client ideas into successful projects that work both aesthetically and commercially.



ARCOINTERIORS CONSULTANCY

Our In-house Interior Design Consultancy. We develop a vision for each project through a carefully evolved process in which we assess the client needs and provide appropriate Designs. Our passion for what we do is reflected by our relentless energy, service, and quality and advocacy fo1 our clients. We consistently deliver interior design concepts that echo the desires of our clients and enhances their lifestyle and business environment in harmony with nature.



ARCO ELECTROMECHANICAL

Our very own in-house provider of electrical, mechanical and plumbing solutions. We offer an astounding level of experience in the field of MEP works. The firm is made up of highly professional engineers who ensure that all the unseen critical aspects of an interior fit-out are functioning smoothly at all times.



ABSONS IT

Absons IT Solutions & Equipment LLC is the technology arm of the Arabian Company investing in valued trust of our customers by providing right IT technology solution th rough professional network of international and local providers that present the experience in the innovative applications of technology to meet the customer requirements.

SICURO



SICURO does Security at its best with a local twist. We simply have the world's most renowned Security Solution brands coupled with a professional team of experts that have a solid understanding of the region, from a technical, legal compliance as well as cultural perspective.

AGH

المجموعة العربية القابضة ذ.م.م
ARABIAN GROUP HOLDING LLC



BARADI

A leading manufacturer specializing in all types of high quality window treatments ranging from manual to motorized curtains and blinds and other treatments that suit the needs of our clients. High Quality Products coupled with the expertise of highly creative designers, a strong production unit and highly professional installers turn dream projects into functional realities.



ARCO EDU & LABS

When it comes to importing and stocking quality material for home, office, education and laboratories, few UAE companies can match the lavish variety of furniture and allied equipment offered by Arco Edu & Labs. Furniture apart, this firm's strength also lies in a special range of electrical and mobile filling storage systems.



PLAY SPACE

Play Space is an established market leader in provision of outdoor and indoor playgrounds equipment, Inflatables, Schools and nurseries furniture, Garden furniture, and Safety flooring. Play Space's main customer markets are municipalities, Landscaping contractors, schools and nurseries, hotels and all other private and government parks.

MMEC **MANNESMANN**

NMEC MANNESMANN

MMEC Mannesmann (MMEC) is an independent EPC CONTRACTOR offering to its customers the full chain of services starting at early study and feasibility project phases up to the project implementation phases on a collaborative basis with our customers, partners and suppliers, we build long term trustful relationships and implement projects in a broad portfolio.



ULTRACARE MEDICAL CENTER

At UltraCare Medical Center we offer a range of cosmetic treatments. These include laser hair removal, dentistry, weight control, Dermatology and skin care. All treatments are done by and under the supervision of our highly skilled doctors. We focus on giving our patients quality medical services, compassionate care, and state-of-the-art technology.



ABSONS GENERAL CONTRACTING

An integral and complementary part of the Arabian Group. It is a fully fledged general contracting firm actively working in the market and delivering well engineered and firmly constructed buildings and structures within the United Arab Emirates.



KAWADER HR CONSULTANCY

Kawader is a premier recruitment Consultancy based in UAE. It offers a hawks-on quality service that allows us to source and work with candidates from a wide range of countries. Kawader provides executive search, overseas recruitment and contract staffing Services for contingencies as well as for turnkey projects and covers the following sectors: Aviation, Banking, Call Center, Construction, Engineering, Hospitality, Healthcare, IT, Media, Office Support also Facilities Management Services.



ARCO OIL AND GAS SERVICES

ARCO Oil & Gas Services managed to become pioneer in supplying specialized products and services along with its principal companies to the Oil, Gas, Power Generation Industries, Water and Energy Sectors, Chemical and Petrochemical Industries, Oil and Gas producers, Drilling Contractors, EPC Contractors, Government and Semi-Government companies and private sector companies in the UAE



UNITED INDUSTRIAL GASES FACTORY

ARCO Oil & Gas Services managed to become pioneer in supplying specialized products and services along with its principal companies to the Oil, Gas, Power Generation Industries, Water and Energy Sectors, Chemical and Petrochemical Industries, Oil and Gas producers, Drilling Contractors, EPC Contractors, Government and Semi-Government companies and private sector companies in the UAE



ICARE CAR CARE AND SERVICES

is our own all-inclusive Car Service & Accessorizing Center. It has been successfully operating in this business for more than a decade and has since been well known for the excellence of its service, quality of its products, and its world-class brands.

OUR SUCCESS STORIES



MUBADALA HQ
400,000,000.00



ADNOC HQ
190,000,000.00



MASDAR HQ
125,000,000.00



AFOCH
168,000,000.00



AL AIN HOSPITAL
100,000,000.00



WTC - ABU DHABI
85,000,000.00



ADIC
28,000,000.00



ADGM
105,000,000.00



TAMM CENTERS & FACTORY
120,000,000.00



SEA WORLD
68,000,000.00



QASR AL WATAN
30,000,000.00



AMAZON DUBAI
160,000,000.00

OUR SUCCESS STORIES



BURJEEL HOSPITAL VPS
210,000,000.00



ABU DHABI MUNICIPALITY HQ
140,000,000.00



EXECUTIVE COUNCIL
25,000,000.00



IPIC HQ
165,000,000.00



F1 CIRCUIT – BUILDING
20,000,000.00



EMIRATES DIPLOMATIC ACADEMY
20,000,000.00



NATURAL HISTORY MUSEUM
64,000,000.00



DELOITTE & TOUCHE
24,000,000.00



DED HQ
95,000,000.00



KHALIFA UNIVERSITY
52,000,000.00



ABU DHABI PORT
24,000,000.00



LE MERIDEAN HOTEL
32,000,000.00



LIST OF MAJOR PROJECTS

Client	Works/ Services Provided	Project Value in AED
Mubadala	Fit-Out and MEP Works	400,000,000.00
IPIC HQ & Vip Office	Turnkey Interior Design, Fit-Out, Furniture and MEP Works	165,000,000.00
ADNOC HQ	Supply of Demountable Partitions	190,000,000.00
Executive Council & Vip Office	Turnkey Interior Design, Fit-Out, Furniture and MEP Works	25,000,000.00
TAMM	Turnkey Interior Design, Fit-Out, Furniture and MEP Works	120,000,000.00
Executive Affairs Authority	Turnkey Interior Design, Fit-Out, Furniture and MEP Works	44,000,000.00
Dewan Ruler & Vip Office	Turnkey Interior Design, Fit-Out, Furniture and MEP Works	46,000,000.00
Baniyas West Development (1626 Villas)	MEP WORKS	570,000,000.00
Masdar	Fit- Out Works	125,000,000.00
Armed Forces Officers Club And Hotel (Afoch)	Turnkey Fit-Out, and Furniture Works	168,000,000.00
WTC (Adnoc)	Turnkey Interior Design, Fit-Out, Furniture and MEP Works	85,000,000.00
Al Ain Hospital	Furniture FF&E lab	100,000,000.00
Burjeel Hospital Vps	Turnkey Interior Design, Fit-Out and MEP Works	210,000,000.00
Amazon Dubai	Fit-out, Furniture and MEP Works	160,000,000.00
Provis Abu Dhabi Municipality HQ	Fit-out and MEP Works	140,000,000.00
Natural History Museum	Fit-out Works	64,000,000.00
Miral Seaworld	Fit-out Works	68,000,000.00
Sea La Vie Project	MEP WORKS	200,000,000.00
ADRIC - Adnoc Research And Innovation Center	Turnkey Interior Design, Fit-Out, Furniture and MEP Works	37,000,000.00
ADGM- Abu Dhabi Global Market	Fit-Out, Furniture and MEP Works	105,000,000.00
ADQCC- Abu Dhabi Quality And Conformity Council	Fit-Out, Furniture and MEP Works	50,000,000.00
ADNOC SPC	Fit-Out, Furniture and MEP Works	30,000,000.00
Deloitte & Touche Dubai & Sharjah Branch	Fit-out, Furniture and MEP Works	24,000,000.00



LIST OF MAJOR PROJECTS

Client	Works/ Services Provided	Project Value in AED
Ministry Of Energy HQ	Turnkey Interior Design, F it-Out, Furniture and MEP Works	20,000,000.00
Ministry Of Defence	Interior Design,Fitout and Furniture Works	21,000,000.00
Presidential Guard HQ	Furniture – FF&E	20,000,000.00
Ad Police HQ	Turnkey Interior Design, F it-Out, Furniture and MEP Works	15,000,000.00
Department Of Health HQ	Turnkey Interior Design, F it-Out, Furniture and MEP Works	80,000,000.00
Abu Dhabi Investment Council & Vip Office	Turnkey Interior Design, F it-Out, Furniture and MEP Works	28,000,000.00
ADMM	Fit-Out, Furniture and MEP Works	15,000,000.00
Qasr Al Watan	Turnkey Interior Design, F it-Out, Furniture and MEP Works	30,000,000.00
Adnoc Refining HQ	Turnkey Interior Design, F it-Out, Furniture and MEP Works	15,000,000.00
Gordonstoun School, Al Jubail Island	Full Construction Work Package	250,000,000.00
DED	Turnkey Interior Design, F it-Out, Furniture and MEP Works	95,000,000.00
Abu Dhabi Port	Fit-Out and Design	24,000,000.00
DCD	Turnkey F it-out, and Furniture Works and MEP Works	17,000,000.00
Ruya Community Islamic Bank	Full Construction Work Package	49,395,498.00
Pure Health Abu Dhabi	Service Renovation & Expansion works - Twam Hospital	13,000,000.00
Khalifa University	Furniture FF&E	52,000,000.00
ADHA HQ & Vip Office	Turnkey Interior Design, F it-Out, Furniture and MEP Works	42,000,000.00
Dubai International Airport	Fit-Out Works	47,000,000.00
DIFC	Fit-Out, Furniture and MEP Works	23,500,000.00
Nobu Hotel & Branded Residences	MEP Works	155,400,000.00
Movenpick (Ras Al Khaimah)	Fit-Out Works	8,600,000.00

OUR COMPANY AWARDS



OUR COMPANY AWARDS

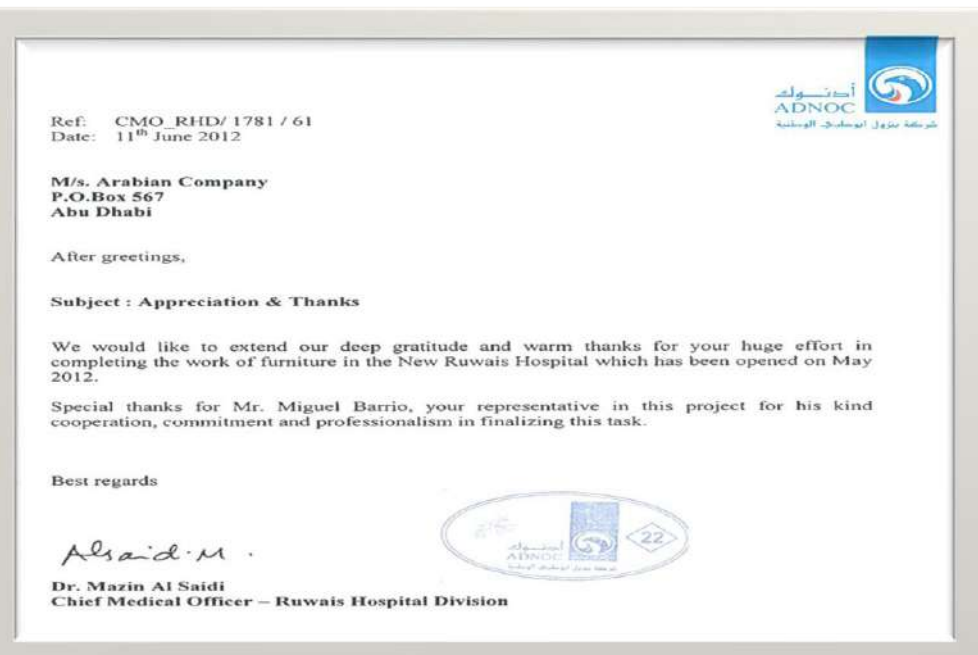

OUR COMPANY AWARDS

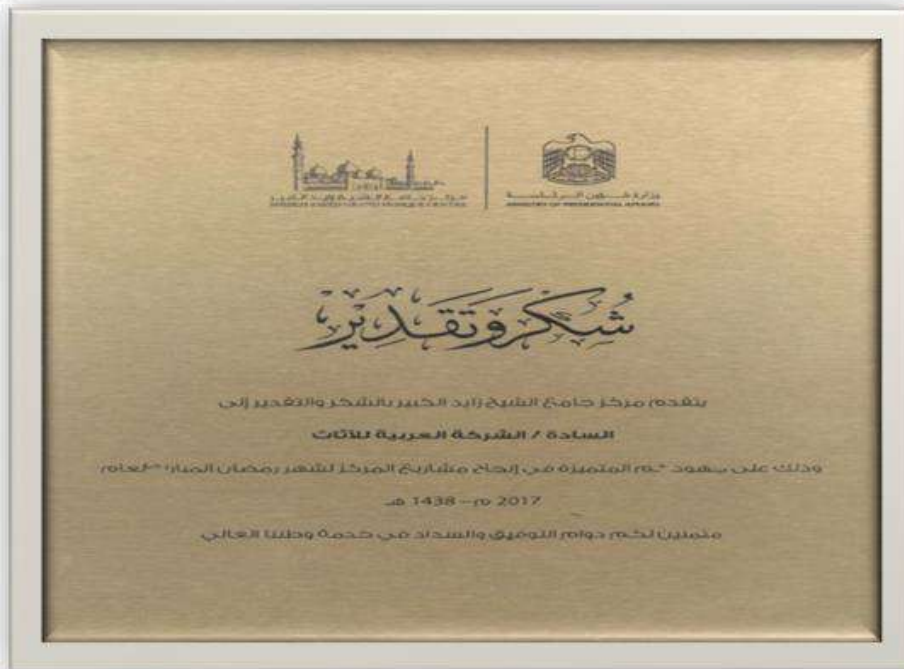



ARCOINTERIORS

DESIGN • BUILD • CHALLENGE

COMPANY PROFILE

Interior DESIGN CONSULTANCY

"Our designs help integrity and our clients reap the rewards."

Each of our design executives has over 13 years of experience across a range of design disciplines, from **commercial and corporate interiors**, to **hospitality, senior living and healthcare environment**.

Our Location:

Sheikh Rashid Bin Saeed Al Maktoum Street
(Old Airport Road) - Al Manhal - W14-DE -
Abu Dhabi

Contact us:

T: +971 2 446 5011

F: +971 2 446 5013

P.O. Box 25475, Abu Dhabi, UAE



www.arcointeriors.com/consultancy

www.arcointeriors.com/consultancy
ARCO Consultancy/Engineering Consultant LLC

ARCO|INTERIORS

ADMM OFFICE



ARCO INTERIORS ADGM ACADEMY

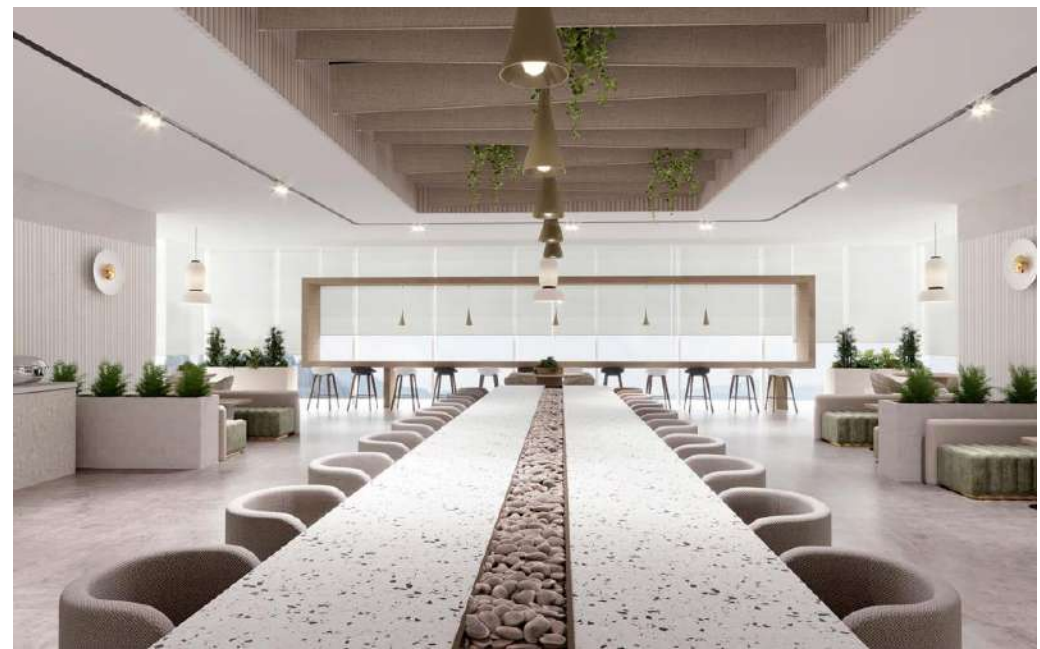
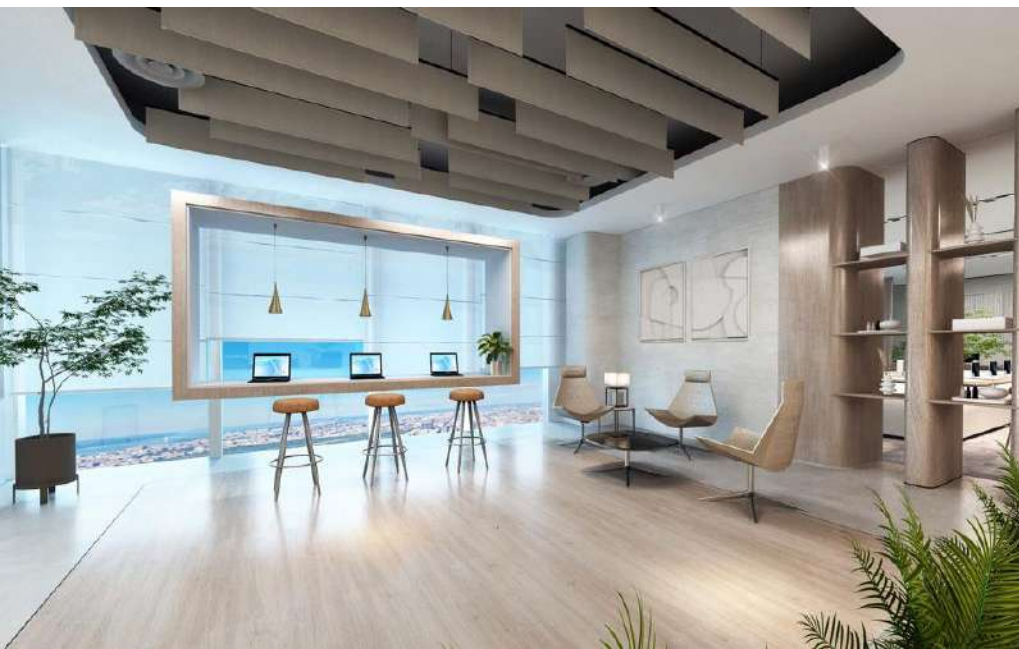

ARCO INTERIORS MUBADALA HQ



ARCO INTERIORS EXECUTIVE AFFAIRS & AUTHORITY









ARCO INTERIORS

AL DHAFRA PETROLEUM



ARCO INTERIORS

ADRIC OFFICE



ARCO INTERIORS

TAMM CENTER



ARCOINTERIORS SEA WORLD



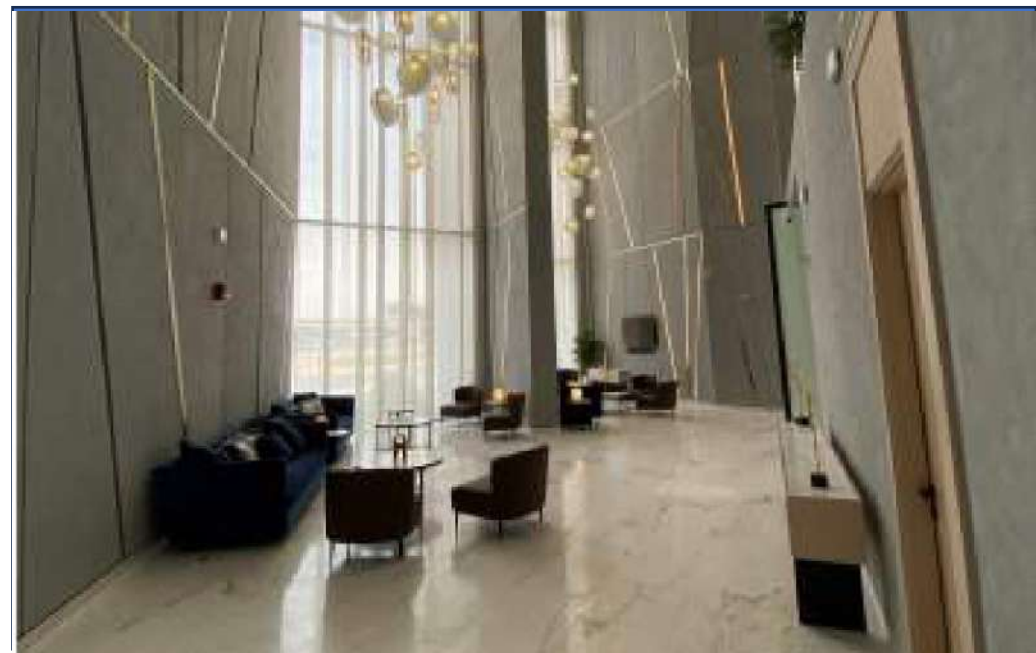
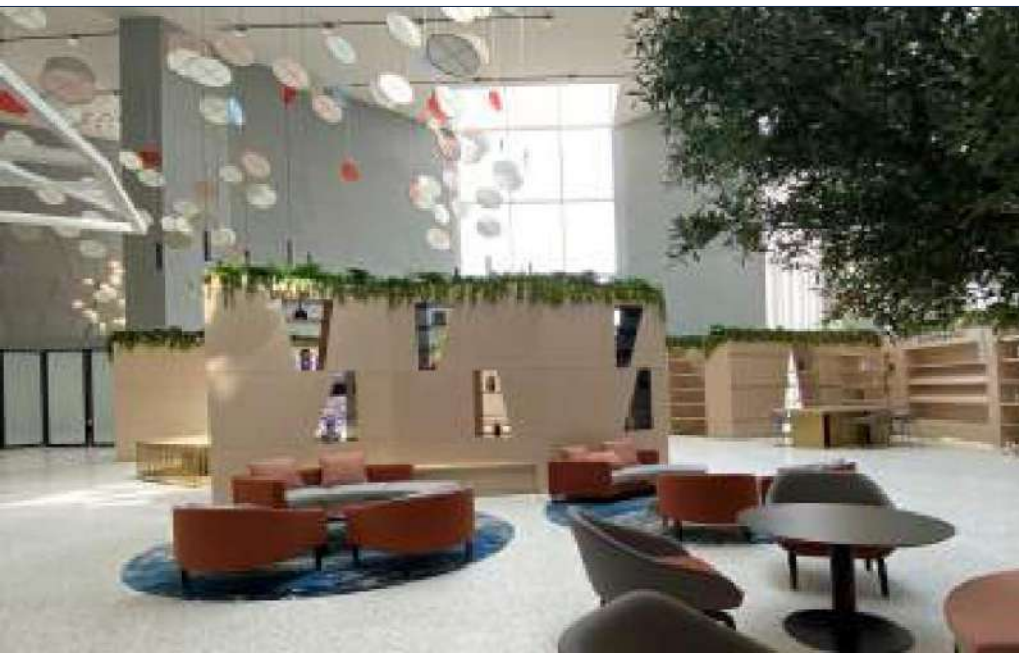

ARCO INTERIORS HYATT CEDTRIC



ARCO INTERIORS

MOVENPICK HOTEL



ARCO INTERIORS HUNA FOOD HALL



ARCO INTERIORS BURJEEL HOSPITAL



ARCO INTERIORS TAJMEEL DENTAL CLINIC AT ALDAR HQ







الشركة العربية
ARABIAN COMPANY

since
1967



Designing for Sustainability
 We work towards better futures for the planet by designing and manufacturing products that respect our natural world, while helping to restore its resources. To do this we: reduce our carbon footprint, design for circularity and choose and use materials responsibly.



Solutions that bring the workplace to life.



Steelcase is a global design and thought leader in the world of work. Along with our expansive community of brands, we design and manufacture innovative furnishings and solutions to help people do their best work in the many places where work happens.

People + Planet
 We believe that doing our best work for the places we all share starts with designing better futures for the wellbeing of people and the planet. We're doing better for people by building community and belonging where everyone feels seen, heard and valued. We're doing better for the planet by transforming our business and committing to a net-zero future to build a more sustainable and resilient world. Because when we do better, we help the world work better.

Steelcase HEALTH Steelcase LEARNING AMQ coalesse

DESIGNTEX HALCON orangebox Smith System viccarbe



Designed to support clinicians in action, Sync workstations facilitate collaboration between colleagues, connection to patients and access to the technologies and information vital to quality care.

A Place to Connect
The Opus overbed table is central to activity and interactions in the patient room. Alongside a bed or recliner, it provides a convenient, adaptable surface for meals and tasks in combination with a surface for clinician use.

Adjustable and easy to move, it serves both sides of the bed and helps give patients a sense of boundary and control over personal belongings. At the same time, it acts as a social bridge where patients, clinicians and family can gather and share.



About Steelcase Learning

At Steelcase Learning, we're passionate about helping to create the conditions for lifelong learning. Our research-based foundations in education and active learning spaces enable us to serve all levels of learning. Working with leading schools and organizations, we measure outcomes and use our Insights to design human-centered solutions and settings that foster greater wellbeing and engagement in learning.



viccarbe

Steelcase



History

Our story is built on people—a passion for learning, creating human and understated products, the sun's influence on our most creative side, constant innovation, engineering, and an unwavering commitment to quality as part of our corporate culture.

Philosophy

Viccarbe is located in Valencia, a marvellous Mediterranean city where we enjoy more than 300 days of sun a year.

We are collaboration

At Steelcase we design and manufacture collaborative design furniture for singular spaces from Valencia to the world.



orangebox

Steelcase



Why Build Walls

Our ongoing programme of meeting pods, for open-plan environments that are scalable, reconfigurable and movable, with a refined level of acoustic and infrastructure performance.

Away from the Desk

A soft landscape system where low and high back units combine to create work and meeting spaces, which range from collaborative and media working booths to larger, more open-plan configurations.



Frezza was founded in 1954 as a family company with long-standing handicraft tradition. The company initially focused on products for the home but, with time and boldness, production was extended to furnishing elements for the office. In 1974, the company specialized in the production of these elements.

A new path was created, characterized by outstanding results and entrepreneurial challenges aiming at making the products more and more innovative and exclusive.

One of these challenges was the creation of Eurosteel Italia in 1987, a company which specializes in the production of metal semi-manufactured goods; then the acquisition of Casamia brand in 1988 or Emmegi between 1990 and 1991.

In 1992, one of the fundamental changes in the industrial evolution of Frezza took place when the company joined Gruppo Doimo. Under this guidance, the company has confirmed its determination to grow.



The Spike executive desk can be integrated with a side extension equipped with a height-adjustable service top, which allows you to change the height of your workstation in just a few moments using a simple remote control.

Functional and discreet details combine the elegant appearance of the service units with excellent craftsmanship, ensuring absolute stability and maximum legroom. A piece of furniture designed to make it easier for people to work.



Social awareness and environmental responsibility are among the fundamental objectives of Frezza's company philosophy. The quality of Frezza's production and production processes for each single product has been guaranteed for years by international certificates and awards. The attention and the devotion required for these awards clearly show how much the company cares for its surrounding territory and witness its deep connection to it.



The modern design of the Ono executive desk is characterised by the robustness and elegance of the aluminium structure combined with quality materials such as wood and leather.

The significant dimensions, with worktops up to 240 cm, make it a symbol of leadership. A thin wooden top rests on a sturdy frame hidden by an aluminium perimetrical frame. The particular aesthetic recess of the desk profile makes it easier to place the seat with armrests next to the worktop. The sliding top is the right solution to keep the work surface in order and be connected at the same time. The opening of the top allows access to the electrical sockets located in the wiring tray below. The opening mechanism is



The Pop Easy collection represents the essence of the operative office and stands out for its essential lines. The flexibility and functionality that define it make it the ideal choice for your working environment.

The metal bridge leg, made with a single square section steel tube (45 mm x 45 mm), is available in white, aluminium and black finishes. The brackets and supports create a 5 mm space between the leg and the work surface, giving a visual sensation of a suspended top.

Intelligently designed, the desks and tables can be easily configured according to the needs of each user.



The Stand By collection was born to give an answer to the changes in human relationships and work approaches.

Stand By is a social collection, designed by the design studio Favaretto & Partners in which the combination of styles with modern and rigorous design has led to a complete series of tables, shelves, sofas, pods and accessories for the office of the



Social awareness and environmental responsibility are among the fundamental objectives of Frezza's company philosophy. The quality of Frezza's production and production processes for each single product has been guaranteed for years by international certificates and awards. The attention and the devotion required for these awards clearly show how much the company cares for its surrounding territory and witness its deep connection to it.



Designed to provide an effective response to the needs of privacy and concentration in open space environments where high levels of soundproofing are essential, the Stand by Limbo pod stands out for the highly technical and aesthetic characteristics that place it at the top of its category.

The self-supporting perimeter is composed by a series of steel panels, subsequently filled with



DV913-Vigo is an executive furnishing collection designed to give a strong and distinctive personality to the office space, a professional habitat characterized by technology and comfort, flexible and open to common areas. In the concept of executive office that the DV913-Vigo project tells, the table is a work of architecture on a reduced scale, a meticulous design element in which the important thickness characterizes the sides and the robust worktops. The structures of the tables highlight the composition between the supporting leg and the aluminum frame. The sculptural contrast of weights and volumes fully identifies the spirit of the Vigo collection.



In particular, the equipped console of the DV910-Oxford line stands out for its multi-functionality and for the variety of uses it offers: in the office or at home, as a practical area for work or study. The console consists of a worktop with cable channel, a drawer available in two widths, a closet area with sliding doors and clothes hanger. The arrangement of the individual elements can be changed according to the needs. Oxford is mainly made of 38 mm thick melamine panels and is available in different colors and finishes.



DV910-Oxford is an executive collection composed of a wide range of furnishing elements able to meet the most varied design requirements. Desks, service units, peninsula desks, integrated modules, meeting tables and multifunctional consoles are characterized by the same aesthetic sign: simple geometries, based on essential lines and shapes, intersect each other and create a highly elegant ensemble. The minimalist effect is dissolved and at the same time enhanced by the combination of different finishes, in particular by the leather-effect inserts, available in three colors, which further emphasize the geometric character of the compositions.



sophisticated love seats and enveloping armchairs embellished with generously-sized tables are the protagonists of the living area. The products, born of different international inspirations, are part of a coordinated and coherent style project.

Forma 5

From Forma 5 and with the collaboration of Ito Design we have developed 3.60, a task chair that accompanies the natural movement of the body and the user is required to maintain stability by increasing the use of muscles and knees. The 3.60 task chair has been designed from the study of ergonomics, physiognomy and kinematics of the human body and, in particular, the postural development in the office throughout the working day.

This important innovation has been investigated in a Biomechanical Analysis Health Centre and it has been certified, with a scientific basis, that it provides greater comfort and is healthier for users.

From Forma 5 and with the collaboration of Ito Design we have developed 3.60, a task chair that accompanies the natural movement of the body and the user is required to maintain stability by increasing the use of muscles and knees. The 3.60 task chair has been designed from the study of ergonomics, physiognomy and kinematics of the human body and, in particular, the postural development in the office throughout the working day.



From Forma 5 and with the collaboration of Ito Design we have developed 3.60, a task chair that accompanies the natural movement of the body and the user is required to maintain stability by increasing the use of muscles and knees. the postural development in the office throughout the working day.



Let's Meet enables both formal and informal meetings between team members, allowing the office space to be converted into useful, productive workspace.

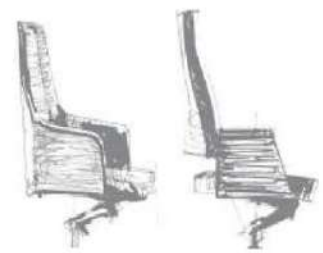

The Company "i 4 MARIANI" is so called because of the 4 brothers Biagio, Tarcisio, Umberto and Emilio that established it on 1957; it is really a family operated company. Now, with the third generation coming soon, each member of the family contributes their own particular competence to provide a role in a well tested mechanism.

The 4 founding fathers - all still active in the Company - ...

The historic company of Mariano Comense told the new trends of Home Design with a new housing concept set up at the Rho Fair spaces. The exhibition space, created in collaboration with Architect Umberto Asnago and Architect Altea Prati for finishes and fabrics, aimed to represent i 4 Mariani and its values, becoming the expression of the solid know-how that distinguishes the made in Italy production of the company specialized for over 60 years, in the realization of unique Italian style and keeping up with the trends of contemporary luxury.



A piece of furniture that declares its character at first sight. It is Master, a conference table that, as the architect Asnago explains, "stands out for its asymmetrical shape which clearly indicates the position of command at the end parts". Characterized by an outer edge in grey stained solid black walnut wood and a top that alternates a saddle leather part with a central part in wood, in the base combines leather doors and fixed elements in solid grey black walnut wood. Many details make Master a



The collection is composed by elements that can be both convexes and concaves. All these elements can freely be assembled obtaining from the more standard compositions to the strangest ones; obviously they can be used also with all the elements of the standard linear add_look collection giving free play to everyone's imagination.



The frame of the relax armchair is composed by two pieces of beech plywood panel curved into a mould, one for the back and one for the seat, fixed together through a solid beech wood part and two metal sheets.

The cushion of the back is a piece of polyurethane cold formed into a mould glued to a thin plywood panel that is fixed to the frame of the back. The seat cushion is made in polyurethane foam covered in polyester wadding. The ottoman is made in beech plywood panel with a polyurethane cushion covered in polyester wadding.

Both the armchair and the ottoman have a round



Basically with Add_Look round we made a new invention: how to hoop the square.

Soft seating

Healthy office

Nowadays, many professions require people to work in offices, sitting at desks in front of computers. In this respect ergonomics has an important task to fulfill. The screen that we daily stare at, the computer mouse under hand and above all the chair on which we sit long hours ... Each element of our surroundings should be designed and adapted to the unique physical features and needs of an individual. This applies especially to the unique parameters of the human body and mind. All this needs to be done to reduce the burden of sitting at the desk for many hours and ensure that an 8-hour working day is creative and effective.



Ergonomics lays the foundations for the creation of an optimum working environment, to tailor it to the physical and mental capabilities of people to the greatest extent and to minimise its impact on health. Ergonomics aims to ensure not only a safe and healthy work place, but also a comfortable one.



The most important element of the Quality Management System is customer orientation, meaning the identification of his/her needs and requirements and their best fulfillment. In our activity we employ the strategy of sustainable development. To ensure the attainment of the established goals in that respect we have implemented the Environmental Management System which enables us to tackle the issue of ecology in a comprehensive manner.



NARBUTAS



Together with the design studio Yonoh, Sancal presents a unique program of occasional tables and seating solutions. Clara and Alex are both from Valencia, a Spanish city renowned for its ceramic tiles, so it seems only fitting that this provided the inspiration for the piece.

Mosaico is a puzzle that can be used to solve a range of different spatial constraints. The bases are made of ash and are available in five measurements upon which marble or wooden tops can be fitted as well as upholstered seat cushions. The optional backs enable the pieces to be transformed into mini-sofas. The hexagonal piece enables, amongst other possibilities, the creation of compositions that make closed



Together with the design studio Yonoh, Sancal presents a unique program of occasional tables and seating solutions. Clara and Alex are both from Valencia, a Spanish city renowned for its ceramic tiles, so it seems only fitting that this provided the inspiration for the piece.

Mosaico is a puzzle that can be used to solve a range of different spatial constraints. The bases are made of ash and are available in five measurements upon which marble or wooden tops can be fitted as well as upholstered seat cushions. The optional backs enable the pieces to be transformed into mini-sofas. The hexagonal piece enables, amongst other possibilities, the creation of compositions that make closed loops. The corner angle adds an element of sinuosity to the design with its curved side.



The wood chosen for the collection is ash, due to its texture and grain. A wide array of stains is available: from natural shades to vibrant colours like pink or yellow. The raised seams help to define the curved lines of the piece.



Clara and Alex have defied the tenets of box-like shapes being used for public areas by using softer forms. Yet, despite its hefty appearance, Sumo has a small footprint (178cm and 92cm for the sofa and armchair respectively).



Our Local Manufacturer Tweet Desks



This managerial-level desk is expertly customized by ARABIAN COMPANY LLC to meet the modern office's demands. Crafted with a durable melamine finish, it offers a clean, contemporary look that complements executive spaces. The desk features a spacious credenza return, providing ample surface area and storage for daily essentials, documents, and devices. Its sleek V-shaped metal legs not only add a modern architectural flair but also ensure robust structural support and stability.

Our Local Manufacturer Desks



UBRAN FASHION

Fashion, simplicity and vitality
Office furniture manufacturing technology is the display of aesthetic concepts and boundless creativity.
Therefore, the practicality of office furniture is not something the designer wants to emphasize at this time.
The presentation of sophistication and artistry is the focus, which reflects a strong and relaxed artistic language.

The simple combination

with the collective space of work, Generous decent appearance, so that limited space is full of boundless passion, The total portfolio of economic and practical, tangible benefits in the same time satisfied different needs with satisfied answer.

A Vision of Comfort and Style

Acuity is a task chair that enhances any environment and any body. Our objective was to build an ergonomically correct chair to instantly and comfortably fit every user regardless of body type. In essence, a chair that adapts to you, not the other way around.



Our Local Manufacturer Tweet Workstations



Our Local Manufacturer Adjustable Workstations

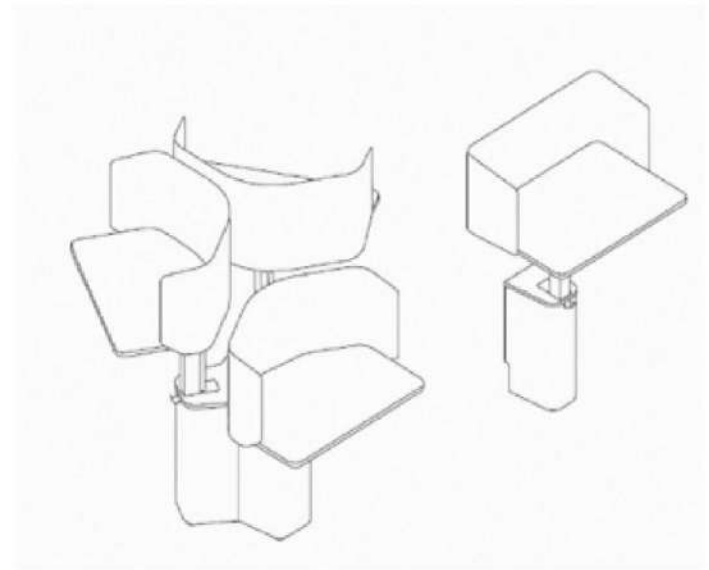

At Imm 2019, the international design fair staged in Cologne, from the 14th to the 20th of January, Ditre Italia presents the exhibition stand project signed by the architect Daniele Lo Scalzo Moscheri, art director of the company. The aesthetics of the stand is emphasized in the elegance of the materials that define it and the way in which they are brought together.

In a flexible compositional scheme, Ditre Italia's experience of living welcomes the company's collections, offering a real usability of each piece, in a free path that allows visitors to satisfy personal needs and curiosity. The projects, signed by designers on the international scene, find space in a series of upholstered and complementary furniture presented as real Ditre Italia total look.



CALIA



ARCO
electromechanical

► AIR CONDITIONING WORKS

- HVAC designing, supply, installation and maintenance for high rise tower buildings, villas, offices, schools, hospitals, shed structures, central air conditioning, chilled water systems, VRF type units, DX systems, control circuit for server room, ductworks, ventilation, and dehumidifiers. Ductwork and ventilation works of all type, chilled water piping and refrigeration plants designing and installation.



► ELECTRICAL WORKS

- All Electrical Work, Lighting, Power, Switch Gears, LV Cables, Lightning & Earthing, Generators, Bus Bar Risers, HV Works, ELV Systems (Lighting Control- Public Address, Structural Cables System, Audio Video Control, CCTV, Access Control & etc...) and Low Current Systems (Fire Alarm, Central Battery & Voice Evacuation).

► ELV AND SECURITY WORKS

- ELV and security solutions such as Structured cabling system; CCTV system; Access control system; Nurse call system; PA/BGM system; master clock system; IP Intercom system; Tetra and packing system; SMATV system; active components, Q Management system, etc.



► FIRE FIGHTING WORKS

- All types of fire fighting related works- piping, sprinkler heads, fire fighting pumps, stand alone type fire (CO₂) extinguishers. Fire Extinguishing systems, fire hydrants and reels cabinets.

► PLUMBING WORKS

- All type of sanitary works, water supply and drainage works related to building, factories, warehouses, clubs etc. storm water drainage, solar water heaters, central filtration and central heating systems.



► INFRASTRUCTURE & EXTERNAL WORKS (UTILITIES)

- External development works, which includes water supply, sewerage, electrical works, IT and security, etc. according to authority regulations and international standards.

ARCO

electromechnical

Completed Projects



REFURBISHMENT & RE-DEVELOPMENT OF THE ARMED FORCES OFFICERS CLUB & HOTEL

Project Value	: 27,000,000 AED
---------------	------------------

HUNA FOOD HALL – ABU DHABI, UAE

Project Value	: 10,000,000 AED
---------------	------------------



Baniyas North Development, Phase 3A & 3B (455 Villas)

Project Value	: 165,000,000 AED
---------------	-------------------



FUTURE SCHOOLS ABU DHABI

Project Value : 76,000,000.AED



RAMHAN LUXURY 321 VILLAS

Project Value : 200,000,000.AED



JUBAIL ISLAND, TOWN CENTER APARTMENTS, ABU DHABI

Project Value : 70,000,000. AED



NEW HOSPITAL DAS ISLAND OFFSHORE ABU DHABI

Project Value : 37,000,000. AED





ابسونز

لأنظمة تقنية المعلومات والمعدات

ABSONS

IT solutions & eEquipments

We are a set of qualified and certified Presales Consultants, Projects Managers, and System Engineers providing state-of-art technology solutions to meet business needs of the local market.

At Absons, management and employees bring together a wealth of international and local work experience & knowledge, from a wide range of products & services in ICT workspace.

Lines of Business

COMPUTING PLATFORM AND STORAGE



- Hardware, System & Storage Solutions
- Virtualization (HW, Server, OS, Applications)
- Applications configuration & Integration
- Desktop, Notebook & Printers
- Data Protection - Backup and recovery

COMMUNICATION NETWORKING AND SECURITY



- Information Security Solution
- Network Solutions (LAN, WAN & Wireless)
- IP Telephony Solution
- Unified Communication, Voice Mailing, IVR

AUDIO VISUAL



- Video wall solutions - indoor and outdoor
- Digital signage & LCD/LFD solution
- Boardroom & Meeting room solutions
- AV system for auditorium & Multi purpose hall
- Interactive screen solution
- IPTV & SMATV solutions
- Control & Command room solutions

EXTRA LOW VOLTAGE



- CCTV & Intrusion Alarm
- Public Address System
- Access Control & Time
- Attendance System
- Gate Barrier & Parking Management System
- Queue Management System
- Master Clock System

Our Value Projects



ADNOC OFFSHORE (ADMA-ADCO)

SCOPE OF WORK

- Communication, Networking & Security
- Design and Implementation of Audio Visual Systems
- Design and Implementation of Server & Storages
- Design and Implementation of ELV Systems



RULER'S REPRESENTATIVE COURT – AL DHAFRAH REGION

SCOPE OF WORK

- Communication, Networking and Security
- Design and Implementation of Audio Visual Systems
- Design and Implementation of ELV Systems
- Data Center and Network Active Components



TAMM SERVICE CENTERS

SCOPE OF WORK

- Design and Implementation of ELV Systems
- Design and Implementation of Server and Storages
- Communication, Networking & Security
- Design and Implementation of Audio Visual Systems



ABU DHABI AIRPORT

SCOPE OF WORK

- Design and Build of Control Room
- Design and Implementation of Audio Visual Systems
- Design and Implementation of ELV systems
- Communication, Networking & Security



ADIC (Abu Dhabi Investment Council)

SCOPE OF WORK

- Design and Implementation of Audio Visual Systems
- Communication, Networking & Security Services
- Design and Implementation of ELV Systems



SEHA (Central Business Office)

SCOPE OF WORK

- Building Complete New Datacenter
- Design and Implementation of Audio Visual Systems
- Communication, Networking & Security Services
- Design and Implementation of ELV systems

Our Value Projects



ERTH (ARMED FORCES OFFICERS CLUB & HOTEL)

SCOPE OF WORK

- Design and Implementation of Structured Cabling System
- Design and Implementation of EIV System
- Design and Implementation of Server and Storage
- Design and Implementation of Network & Security
- Design and Implementation of UPS System



ABU DHABI QUALITY AND CONFORMITY COUNCIL

SCOPE OF WORK

- Communication, Networking and Security
- Design and Implementation of Audio Visual Systems
- Design and Implementation of EIV Systems
- Data Center and Network Active Components



TADWEER

SCOPE OF WORK

- Design and Implementation of Structured Cabling System
- Design and Implementation of Access Control System
- Design and Implementation of Speed Gate Intercom System
- Design and Implementation of Audio Visual System
- Migration of Existing Data Center from Old HQ to New HQ



ADHA (Abu Dhabi Housing Authority)

SCOPE OF WORK

- Building Complete New Datacenter
- Communication, Networking & Security
- Design and Implementation of Audio Visual Systems
- Design and Implementation of Server & Storages
- Design and Implementation of EIV Systems



ADNOC GLOBAL TRADING

SCOPE OF WORK

- Building New Datacenter and IDFs
- Communication, Networking and Security
- Design and Implementation of Audio Visual Systems
- Computing Platform and Storage



NATIONAL MEDIA COUNCIL

SCOPE OF WORK

- Communication, Networking and Security
- Design and Implementation of Audio Visual Systems
- Design and Implementation of EIV Systems
- Data Center and Network Active Components



sicuro.
security systems l.l.c.

Detectors



- Walk through metal Detector
- Ground Search Metal Detector
 - Wire Detectors
 - Non-metallic conductive detectors
 - Ground Penetration Radar (GPR)
 - Deep Search Metal Detector
 - Hand held detector
 - ON-VEHICLE Detectors
 - Deep Water Metal Detector
- Explosives & Narcotics Detector
- Mail Screening Devices
- CBRNE
- X-Ray Inspection
- Portable X-Ray Scanner
- Go-Scan C-View
- Magneto Static Detector
- People Screening System
- Under Vehicle Scanner

Barriers

- Vehicle Barriers
 - Bollards
 - Road Blockers
 - Tyre Killers
 - Gate Barriers
- People Barriers
 - Speed Gates



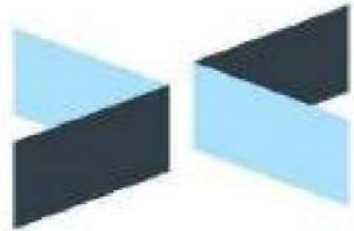

SMART
d i m e n s i o n s





Demountable Acoustic Partition

Single Glass, Double Glass & Solid Partitions

Acoustic Pod

Telephone & Meeting



ACCESSORIES

- Fire Rated Partitions
- Back Painted Glass
- Mirrors
- Magic Stickers
- Smart Films
- Louver Panels
- Wall cladding Panels



Electrical & Manual Movable Partitions



MONOBLOCK PARTITION FOR VOID AND HIGH SYSTEM

Steel / Glazed partition.
Maximum 3600mm full height.
Glazing is secured to extruded aluminium floor and ceiling rails.



ACOUSTIC FABRIC, FELT, MDF PANELS

Our Acoustic Panels delivers clever solutions for every situation, from demanding recording studios to offices, restaurants, buildings, industry, offices and schools.

- a. **ESK ACOUSTIC PANELS**
- b. **FLEXIBLE PANELS**
- c. **CAIMI ACOUSTIC PANELS**



Clipso Stretched Ceiling is made of polyurethane-coated polyester mesh. Width up to 5meters by 50meters without joints or seams. Clipso profile Innovative ABS, ALU and PVC profiles

Cold and dry installation

With cold fitting, installation is quick and easy, and 100% environmentally-friendly. This system reduces dust, odours, disruption and energy consumption

Acoustic covers

A room's acoustics are an essential aspect when it comes to offering a positive visitor experience. Our acoustic solutions reduce noise pollution, giving rooms a more pleasant feel.

NRC upto 0.85

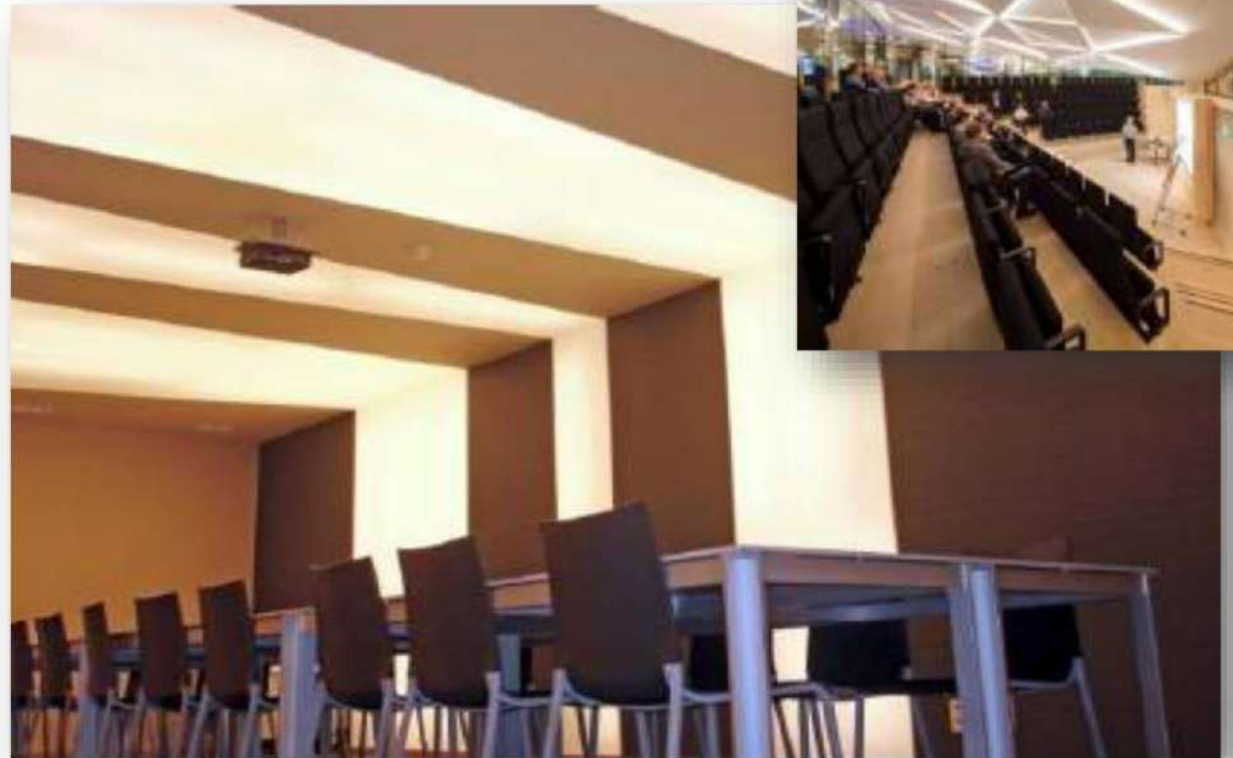



تخزين

TAKHZEEN

YOUR TOTAL
FILING & STORAGE
SPECIALIST



Vertical Computerized Storage Cabinets

Offices, hospital, hotels & Industrial applications



Electrical & Manual Mobile Shelving Systems on Rails

Gun Cabinets
Refile M16 & Pistol



Automatic Carousel Filing Rotoamt



ACCESSORIES

- Handling equipment's,
- Plastic & Wooden Pallets
- Decking (GI / Wire Mesh)
- SS Tables / benches
- ESD Workbench
- Plastic Bins
- Jack Pallet
- Trolley & Ladder

Warehouse Racks

Heavy & Light Duty Shelves





تخزين
TAKHZEEN

KOSTAL SHREDDER MACHINES

SAFETY LEVELS



P-1

SECURITY LEVEL 1

Particle size ≤ 2000 or strip width ≤ 12 . Unlimited strip length.



P-2

SECURITY LEVEL 2

Particle size ≤ 800 or strip width ≤ 6 . Unlimited strip length.



P-3

SECURITY LEVEL 3

Particle size ≤ 320 or for example particles 6×50 or strip width ≤ 2 . Unlimited strip length.



P-4

SECURITY LEVEL 4

Particle size ≤ 160 and for regular particles: strip width ≤ 6 . (for example particles 6×40).



P-5

SECURITY LEVEL 5

Particle size ≤ 30 and for regular particles: strip width ≤ 2 . (for example particles 2×15).



P-6

SECURITY LEVEL 6

Particle size ≤ 10 and for regular particles: strip width ≤ 1 . (for example particles 0.8×12).



P-7

SECURITY LEVEL 7

Particle size ≤ 5 and for regular particles: strip width ≤ 1 . (for example particles 0.8×5).



**Recycling
Shredder**



**Document
Shredder**



**Industrial
Shredder**



FLOORS & MORE



Steel Cementitious raised access floor

Floors and More Provide Full steel combination Framework with strong intension, high Size precision and good interchangeability. Fireproofing, waterproof, four sides are fixed Very well to avoid moving of floor with good Walking feel, the mould of outlet interface is Molding, Bing stable performance in humidity Temperature.



Wood Core raised access floor

Floors and More provide the Bare Panels are Modular panels 600 x 600 resting on a suitable Support structure in steel available in different Measurements. The core of the panels is made Of wood core, fully encapsulated in steel, with Single or double alufoil backing, with the tongue & groove interlocking system.



Altro Whiterock Digidclad (Wall)

With Altro Whiterock Digidclad, you can produce high quality, life-like images that include all the hygienic and functional attributes of Altro Whiterock. With vector artwork, these images can span multiple panels or could be used singularly as a design element. The choice is yours and the design opportunities are endless

Altro Tierra (Static-conductive flooring)

Altro Tierra is a static-conductive, flexible vinyl flooring system with permanent anti-static properties*. It gives the highest level of protection against Electro Static Discharge (ESD), when conductive footwear is worn.





Carpet Tiles

Carpet tiles, also known as carpet squares or Modular carpet, are a modern and stylish for The raised floor spaces. These carpets are most Prominent in the commercial sector. Carpet Tiles comes with quality backing systems as They provide dimensional stability and help Carpet tiles withstand moisture. Carpet tiles Offer freedom of design, allowing you to give More depth and texture to a room.



Axminster

Floors & More's Axminster carpets are well Known for their designs and elegance. They Are rightly regarded as one of the finest quality Axminster available and are reputed as the Carpet for luxury. Floors & More has Partnered With the world-renowned brand for Axminster Carpet.



Hand Tufted

The process for creating a hand tufted carpets Differs greatly, as it is made by punching strands Of wool into a canvas which is stretched on a Frame. This is accomplished with the help of A hand operated tool. This process is not very Time intensive. After pilling with wool, the carpet Is removed from the frame and a scrim fabric Is glued to the back. To complete the carpet, a Fringe is added by either sewing on or gluing.

Machine Tufted

A machine tufted carpet is a process of creating Carpet on specialized multi - needle sewing Machines, Several hundred needles stitch Hundreds of rows of pile yarn tufts through a Backing fabric called the primary backing.





FLOORS
& MORE



Woven Fabric Backing

Floor and More provide with hundreds of fabric Backed vinyl wallcovering designs and literally Millions of colour options. Whether classic Or contemporary design, there's a wealth of Inspiration in our unrivalled ex-stock fabric-Backed vinyl wallcovering collections. Our range Of textures, prints and metallics, plus a custom Design service, allows you the freedom to be Creative,





BARADI
CURTAINS

“Bringing you the world famous curtains at affordable prices”

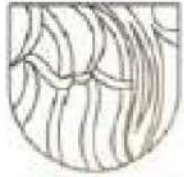

BARADI
CURTAINS

Baradi Curtains; established in 2013. It has been the leading provider in the market with total solution for all type of Window Treatment with the best products and services in catering the needs of our clients.

High Quality Products coupled with the expertise of highly creative designers and skilled craftsmen enable to turn dream Projects into functional realities.



**BARADI
CURTAINS
TRADING LLC**

"Bringing you the world famous curtains at affordable prices"



www.baradi.ae



Our Main Business Activities

- **Manual & motorized Curtain**
- **Privacy Curtain**
- **Stage Curtain**
- **Manual & Motorized Roller blind**
- **Roman Blind**
- **Vertical Blind**
- **Aluminium Venetian Blind**
- **Wooden Venetian Blind**
- **Solarette Blind**
- **Combi Blind**
- **Skylight Blind**
- **Carpt**
- **Wallpaper**
- **Parquet & Vinyl Flooring**
- **Upholstery**

Our Sectors

- *Hospitality*
- *Commercial*
- *Residential*
- *Healthcare*



Completed Projects

- *Duke Oceana Hotel, JBR Dubai*
- *Saif Al Marsa Hotel, Dubai*
- *Fairmont Hotel, Abu Dhabi*
- *Public Prosecutors Office, Abu Dhabi*
- *ADNOC Business Center, Abu Dhabi*
- *Sheikh Khalifa Medical City*
- *Federal Supreme Court, Abu Dhabi*
- *Le Meridien Hotel, Abu Dhabi*
- *Radisson Blu, Abu Dhabi*
- *Sheikh Khalifa Central Hospital, Fujairah*
- *Al Ain Municipality*
- *Summit International School*
- *Al Falah Schools*





EDULAB

Furniture & Equipment Solutions

EDULAB has a complete range of **educational furniture, laboratories furniture, libraries furniture, outdoor furniture, playground, fitness and sport equipments** to provide a unique Educational Environment suitable for modern schools , universities and institutions.





PLAY SPACE Outfit Games Trading L.L.C
is specialist company in;

- Children playground equipment, including outdoor playground, indoor playground,
- Water slide
- Water fun equipment
- Outdoor fitness
- Inflatable bouncers
- Preschool toys, swing and other playground accessories.

Playground

A **playground**, **play park**, or **play area** is a place specifically designed to enable children to play there. It is typically outdoors. While a playground is usually designed for children, some target other age groups.



Park & Urban Furniture

Park and urban Furniture range includes: benches, picnic tables, benches, litter bins, ashtrays, cycle storage and other **park furniture** for relaxation and social interaction are designed to blend into and enhance public areas.



Sport & Fitness

Exercising is a fundamental way of improving the health and well-being of children, young people and adults. We feel it is important to provide equipment that facilitates the need for non-traditional sports in order to tackle physical inactivity, obesity and preventable health conditions.





United Industrial Gases Factory LLC
مصنع المتحدة للغازات الصناعية ذ.م.م

United Industrial Gases Factory L.L.C

United Industrial Gases Factory L.L.C. (UIGF), established in **2012**, is part of **Arabian Group Holding**, founded in 1967 by the late Mr. Ali Baslaib. Located in **ICAD 3, Abu Dhabi**, UIGF manufactures industrial gases including **oxygen, nitrogen, argon, and acetylene**, and supplies medical, specialty, food-grade, and high-purity gases, along with gas cylinders, racks, and related equipment.

Our Vision

To be a leading regional and world-class manufacturer and supplier of **industrial and medical gases**.

Our Mission

To deliver high-quality gases with a strong commitment to **safety, efficiency, and customer value**, while investing in our people and long-term operational excellence.





GAS PRODUCTS

- [Acetylene \(C₂H₂\)](#)
- [Argon \(Ar\)](#)
- [Carbon Dioxide \(CO₂\)](#)
- [Helium \(He\)](#)
- [Hydrogen \(H₂\)](#)
- [Nitrogen \(N₂\)](#)



ARABIAN AS A CORPORATE ARABIAN GROUP OF COMPANIES,

Arabian Group, founded in **1967** by the late **Mr. Ali Baslaib**, is a leading UAE-based importer and stockist of **office and home furniture, storage systems, and oilfield supplies**. Guided by integrity and quality, the group delivers reliable solutions through strong industry knowledge, professional teams, and long-term client relationships.

Our Mission

To become a leading and trusted player in the UAE market by delivering specialized solutions and services across diverse sectors, including international companies, fast-growing enterprises, and government entities, while building strong and lasting relationships.

Our Vision

To strengthen stakeholder value by achieving sustainable growth in revenue and profitability, positioning ARCO as a reliable, attractive, and trusted organization for clients, partners, and investors.

CLIENT LIST

In our service record, we supplied a variety of Products and Services to most of the Oil Field Companies and EPC Contractors within the UAE.

List of major companies, but not limited to;

ADNOC, ADNOC ONSHORE, ADNOC GAS PROCESSING, ADNOC OFFSHORE, ADNOC REFINING, ADNOC DRILLING, ADNOC LNG ETC..

- **TOTAL ABK**
- **NPCC**
- **McDERMOTT**
- **SAIPEM**
- **TECHNIP**
- **CPECC**
- **PETROFAC**
- **SNAMPROGETTI**
- **FLUOR MIDEAST**
- **TOTAL E&P YEMEN**
- **BECHTEL**
- **DODSAL**
- **LAMPRELL**
- **PETRONASH**
- **ALDERLEY**
- **FORTUNE ENGINEERING**
- **CAT**
- **AL ASAB**
- **GALFAR**
- **ADVANCED PETRO SERVICES**



WHAT WE DELIVER



ABSONS GENERAL CONTRACTING LLC

ABOUT OUR COMPANY

ABSONS General Contracting LLC is an integral part of the Arabian Group Holding. It is a full-fledged general contracting firm actively working in the market and delivering well engineered and firmly constructed buildings and structures within the United Arab Emirates.

Our Services:

- **Building Contracting:** Turnkey construction for residential, commercial, and institutional projects.
- **Steel Construction:** Structural and architectural steel works with precision and durability.
- **Electrical & Mechanical (MEP):** Integrated MEP solutions for buildings, energy, and oil & gas projects, compliant with ADNOC and other international standards.
- **Facility Maintenance:** Preventive and corrective maintenance to ensure asset performance and longevity.
- **Onshore & Offshore Oil & Gas Services:** Specialized support services for oil & gas facilities in line with HSE and industry standards.



PROJECTS IN PROGRESS



RUYA BANK
AED 49,000,000



GORDONSTOUN SCHOOL
AED 250,000,000



GEMS SCHOOL
AED 37,500,000

COMPLETED MAJOR PROJECTS



**BURJEEL SPECIALTY
HOSPITAL, SHARJAH
AED 81,000,000**



**PRIVATE VILLA
AED 22,000,000**

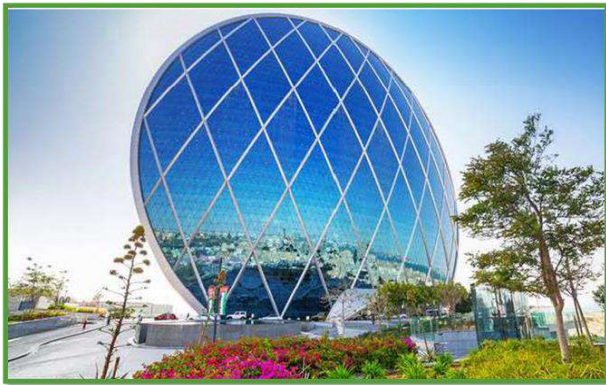

**TAJMEEL DENTAL
CLINIC, ALDAR HQ
AED 12,000,000**



**BURJEEL ROYAL
HOSPITAL, AL AIN
AED 75,000,000**



KAWADER

HR Consultancy



info@kawader.biz



026919000

KAWADER BUSINESS LINES

- recruitment services
- staffing services
- search and selection services
- localization services
- overseas recruitment services
- kawader management services



EXECUTIVE SEARCH



OVERSEAS HIRING



TEMPORARY STAFFING



MANAGEMENT SERVICES



EMIRATIZATION



PERMANENT STAFFING

Clients ... and More





MMEC **MANNESMANN**

Airport Road, Al Wifaq Finance Tower, 15th Floor Abu Dhabi, UAE

Telephone: +971 (2) 6311655

E-Mail: info@mmecc-mannesmann.ae

www.mmecc-mannesmann.ae

Our Fields of Services



Consulting Services

- Business Development
- Market Intelligence
- Value Chain Analysis
- Financing Services
- Technical Consulting
- Advisor to Banks and Insurances



Studies & Conceptual Design

- Value Engineering
- Conceptual Engineering
- Process Optimisation
- Risk Assessment
- Cost - Benefit analysis
- Cost Estimation
- Assets Evaluation

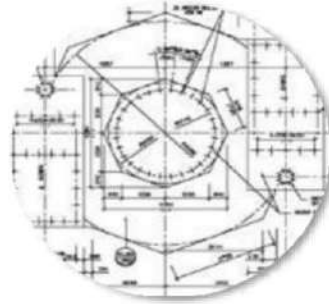

Basic Engineering & FEED

- Value Engineering
- Process Simulation
- Hydraulic Simulation
- Cost Estimating
- QHSE Management
- Authority Engineering
- RAM Study
- O&M Philosophies



EP(C) Implementation

- Project Management
- QHSE Management
- Controlling
- FEED Verification
- Detail Design
- Risk Management
- Procurement & Transport
- Expediting & QA/QC
- Construction & Sub-contractor Management
- Commissioning & Start up



After Sales Services

- Spare Parts
- Operational Service
- Debottlenecking
- Verification for new Feed-Stock
- Product yield optimisation

From Study to EPC Implementation

GREEN HYDROGEN

Hydrogen Station
MMEC Mannesmann

Green hydrogen is emerging as a transformative force in the United Arab Emirates (UAE), signaling a commitment to sustainable energy practices. The UAE, a global hub for innovation and development, is actively embracing green hydrogen as a key component of its clean energy strategy

MMEC Mannesmann is pioneering the use of green hydrogen in the UAE with the establishment of the first hydrogen-fueled stations.

This groundbreaking initiative includes a station strategically positioned in **Masdar City**, a hub for renewable energy and sustainable technologies, and another station located in the vibrant city of **Dubai**.

These stations mark a pivotal step towards a more sustainable and environmentally conscious future, showcasing MMEC Mannesmann's commitment to driving innovation and contributing to the UAE's position at the forefront of the green energy transition.



AGH

المجموعة العربية القابضة ذ.م.م
ARABIAN GROUP HOLDING LLC